SPRAY PRO 300H

USER OPERATIONMANUAL



Grupo Elastoford
Sol Banus Consulting S.L Import- Export
Representantes en España de SPRAY PRO MACHINERY
Calle Plata 13 Polígono La Ermita Marbella 29603 Málaga



Grupo Elastoford
Sol Banus Consulting S.L Import- Export
Representantes en España de SPRAY PRO MACHINARY
Calle Plata 13 Polígono La Ermita Marbella 29603 Málaga



Important Safety Instructions

Read all warnings and instructions in this manual. Save these instructions.

Warning:

1. Put gun into DOP liquid (we send sample with machine, you can buy from your market) after finishing one day's work
2. It is necessary to start machine and cycle ISO and POLY material if machine don't work extend 4 working days.
3. ISO and POLY material must be pushed out by DOP liquid when machine don't use more than 15 working days.

See model information as fellows, including maximum working pressure, approvals and standard configuration.

Model	SP 300H
Max working pressure	17MPa (170 bar) 150 bar open fluid camera 01/ 160 bar camera 00 -110 bar camera 02/03
Max hose length	120m
Max fluid temperature	88°C (190°F)
Max output	24kg/min
Maximum output pressure	18 MPa
Heater power	6000W each side
Heating hose power	1000W/15m
Whole power	17.000W
Power source	230V 3phase,400V 3phase,50/60HZ
Machine size	870×700×1150mm

Standard configuration:

Proportion Fixed Mainframe 1 set
Self-cleaning foaming gun 1 set
Feeding pump 2 sets
Heating hose 49.2 feet (15m)
Connecting hose from feeding pump to machine 10 feet(3m)
Connecting hose from heating hose to gun 5 feet(1.5m)
Rings and Tools
User operation manual

READ ME FRIST, IT IS VERY IMPORTANT:





1. Red hose for ISO, Blue hose for POLY. Never try to exchange them if you put pumps or hose into polyurethane material, even it is wrong;
2. After one day's work, put the gun into the Ethylene glycol monomethylether;
3. After one day's work, put the pump feet into the DOP;
4. If you do not use the machine more than one week, clean the machine (pump, hose and foaming gun), details refer to "6.5 Operation of long-term shutdown".











Contents



1. Warnings.....	5
2. Important Two-Component Material Information.....	9
3. System Installation	11
4. System Operation	21
5. Check for Fluid Flow System and Equipment Problems.....	26



1. Warnings

The following warnings are for setup, use, grounding, maintenance, and repair of this equipment. The exclamation point symbol alerts you to a general warning and the hazard symbol refers to procedure-specific risk. Refer back to these warnings. Additional, product-specific warnings may be found throughout the body of this manual where applicable.





 WARNING	
	<p>ELECTRIC SHOCK HAZARD</p> <p>This equipment must be ground. Improper grounding, setup, or usage of the system can cause electric shock.</p> <ul style="list-style-type: none"> • Turn off and disconnect power at main switch before disconnecting any cables and before servicing equipment. • Connect only to grounded power source. • All electrical wiring must be done by a qualified electrician and comply with all local codes and regulations.
	<p>TOXIC FLUID OR FUMES HAZARD</p> <p>Toxic fluids or fumes can cause serious injury or death if splashed in the eyes or on skin, inhaled, or swallowed.</p> <ul style="list-style-type: none"> • Read MSDS to know the specific hazards of the fluids you are using. • Store hazardous fluid in approved containers, and dispose of it according to applicable guidelines. • Always wear chemically impermeable gloves when spraying, dispensing, or cleaning equipment.
	<p>PERSONAL PROTECTIVE EQUIPMENT</p> <p>You must wear appropriate protective equipment when operating, servicing, or when in the operating area of the equipment to help protect you from serious injury, including eye injury, inhalation of toxic fumes, burns, and hearing loss. This equipment includes but not limited to:</p> <ul style="list-style-type: none"> • Protective eyewear • Clothing and respirator as recommended by the fluid and solvent manufacturer • Gloves • Hearing protection



 WARNING	
  	<p>SKIN INJECTION HAZARD</p> <p>High-pressure fluid from gun, hose leak, or ruptured components will pierce skin. This may look like just a cut, but it is a serious injury that can result in amputation. Get immediate surgical treatment.</p> <ul style="list-style-type: none"> • Engage raw material valve lock when not spray. • Do not point gun at anyone or at any part of the body. • Do not put your hand over the spray tip. • Do not stop or deflect leaks with your hand, body, glove, or rag. • Turn off the machine when you stop spraying and before cleaning, checking, or servicing equipment. • Tighten all fluid connections before operating the equipment. • Check hoses and couplings daily. Replace worn or damaged parts immediately.
   	<p>FIRE AND EXPLOSION HAZARD</p> <p>Flammable fumes, such as solvent and paint fumes, in work area can ignite or explode. To help prevent fire and explosion:</p> <ul style="list-style-type: none"> • Use equipment in well ventilated only. • Eliminate all ignition sources; such as pilot lights, cigarettes; plastic drop cloths, and portable electric lamps. • Keep work area free of debris, including solvent, rags and gasoline. • Do not plug or unplug power cords, or turn power or light switch on or off when flammable fume are present. • Ground all equipment in the work area. • Hold gun firmly to side of grounded pail when triggering into pail. • If there is a static sparking or you feel a shock, stop operation immediately. Do not use equipment until you identify and correct the problem. • Keep a working fire extinguisher in the work area.
  	<p>THERMAL EXPANSION HAZARD</p> <p>Fluid subjected to heat in confined spaces, including hoses, can create a rapid rise in pressure due to the thermal expansion. Over-pressurization can result in equipment rupture and serious injury.</p> <ul style="list-style-type: none"> • Open a valve relieves the fluid expansion during heating. • Replace hoses proactively at regular intervals based on your operation conditions.

 WARNING	
	<p>PRESSURIZED ALUMINUM PARTS HAZARD</p> <p>Use of fluids that incompatible with aluminum in pressurized equipment can cause serious chemical reaction and equipment rupture. Failure to follow this warning can result in death, serious injury, or property damage.</p> <ul style="list-style-type: none"> • Do not use 1,1,1-trichloroethane, methylene chloride, other halogenated hydrocarbon solvents for fluids containing such solvents. • Many other fluids may contain chemicals that can react with aluminum. Contact your material supplier for compatibility.
	<p>EQUIPMENT MISUSE HAZARD</p> <p>Misuse can cause death or serious injury.</p> <ul style="list-style-type: none"> • This equipment is for Professional use only. • Do no leave the work area while the equipment is energized or under pressure. Turn off all equipment when the equipment is not in use. • Do not operate the unit when fatigued or under the influence of drugs or alcohol. • Do not exceed the maximum working pressure or temperature rating of the lowest rated system component. See Technical Data in all equipment manual. • Use fluids and solvents that are compatible with equipment wetted parts. See Technical Date in all equipment manuals. Read fluid and solvent manufacturer's warnings. For complete information about your material, request MSDS forms from distributor or retailer. • Check equipment daily. Repair or replace worn or damaged parts immediately with genuine manufacturer's replacement parts only. • Do not alter or modify equipment. • Use equipment only for its intended purpose. Call your distributor for information. • Route hoses and cables away from traffic areas, sharp edges, moving parts, and hot surfaces. • Do not kink or over bend hoses or use hoses to pull equipment. • Keep children and animals away from work area. • Comply with all applicable safety regulations.

 WARNING	
	<p>MOVING PARTS HAZARD</p> <p>Moving parts can pinch or amputate fingers and other body parts.</p> <ul style="list-style-type: none"> • Keep clear of moving parts. • Do not operate equipment with protective guards or covers removed. • Pressurized equipment can start without warning. Before checking, moving, or servicing equipment, follow the Pressure Relief Procedure in this manual. Disconnect power or air supply.
	<p>BURN HAZARD</p> <p>Equipment surfaces and fluid that's heated can become very hot during operation. To avoid severe burns, do not touch hot fluid or equipment. Wait until equipment/fluid has cooled completely.</p>

2. Important Two-Component Material Information

Isocyanate Conditions	
    	<ul style="list-style-type: none"> • Spraying or dispensing materials containing isocyanates creates potentially harmful mists, vapors, and atomized particulates. • Read material manufacturer's warnings and material MSDS to know specific hazards and precautions related to isocyanates. • Prevent inhalation of isocyanate mists, vapors, and atomized particulates by providing sufficient ventilation in the work area. If sufficient ventilation is not available, a supplied-air respirator is required for everyone in the work area. • To prevent contact with isocyanates, appropriate personal protective equipment, including chemically impermeable gloves, boots, aprons, and goggles, is also required for everyone in the work area.

Material Self-ignition	
 	<p>Some materials may become self-igniting if applied too thickly. Read material manufacturer's warnings and material MSDS.</p>

Keep Components A and B Separate



Cross-contamination can result in cured material in fluid lines which could cause serious injury or damage equipment. To prevent cross-contamination of the equipment's wetted parts, never interchange component A (isocyanate) and component B (resin) parts.

Moisture Sensitivity of Isocyanates

Isocyanates (ISO) are catalysts used in two component foam and polyurea coatings. ISO will react with moisture (such as humidity) to form small, hard, abrasive crystals, which become suspended in the fluid. Eventually a film will form on the surface and the ISO will begin to gel, increasing in viscosity. If used, this partially cured ISO will reduce performance and the life of all wetted parts.



The amount of film formation and rate of crystallization varies depending on the blend of ISO, the humidity, and the temperature.

To prevent exposing ISO to moisture:

- Always use a sealed container with a desiccant dryer in the vent, or a nitrogen atmosphere. Never store ISO in an open container.
- Keep the ISO lube pump reservoir (if installed) filled with DOP. The lubricant creates a barrier between the ISO and the atmosphere.
- Use moisture-proof hoses specifically designed for ISO, such as those supplied with your system.
- Never use reclaimed solvents, which may contain moisture. Always keep solvent containers closed when not in use.
- Never use solvent on one side if it has been contaminated from the other side.
- Always lubricate threaded parts with ISO pump oil or grease when reassembling.

Changing Materials





- When changing materials, flush the equipment multiple times to ensure it is thoroughly clean.
- Always clean the fluid inlet strainers after flushing.
- Check with your material manufacturer for chemical compatibility.
- Most materials use ISO on the RED side, but some use POLY on the BLUE side.

					
<p>If any possible that the released water would touch electrical appliance, you must catch the water with a container, avoiding personal injury.</p>					

3. System Installation

3.1 Installation of raw material pipe system:

Lead the POLY and ISO from material drum to the pump entrance of the host machine; connect hoses of chemical material and gas to PU foaming gun respectively as the following steps.

					
<ul style="list-style-type: none"> • Before install the raw material pipe, make sure the equipment is not electrified. • Under ordinary pressure, the foaming agent will expand intensively when the temperature of raw material more than 24°C. Then the raw material will erupt from drum if you open the drum lid at this time. So please be careful when you open the drum and prepare something for protection, like cloth and mat, to avoid personal injury. • When opened halfway, you'll hear sound of air bleeding. After air over, open the drum completely. 					

3.1.1 Installation of material feeding system:

3.1.1.1 Open the drum put in the material feeding pump slowly till to the bottom. Make sure the tilt angle of the pump not more than 30°. As figure (2)

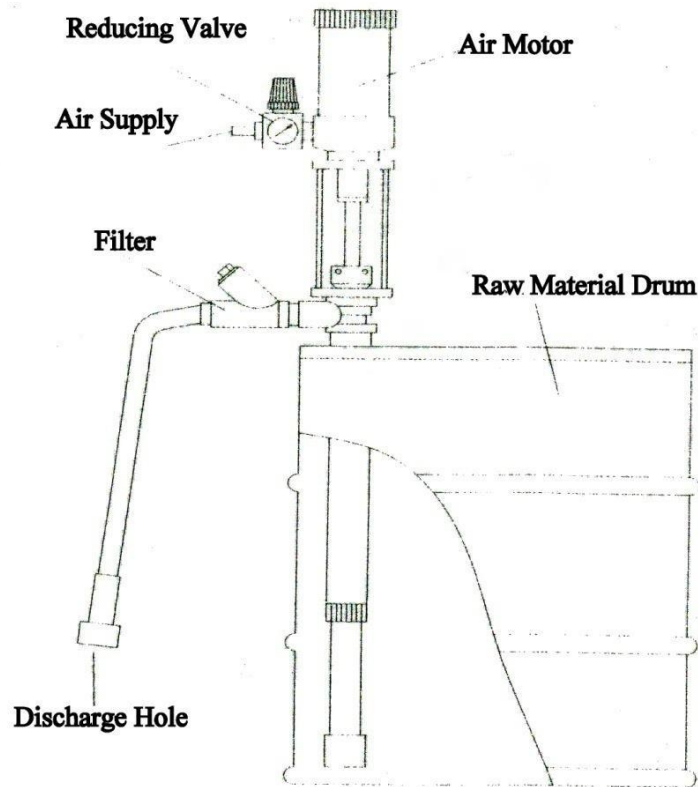

Figure (2)

3.1.1.2 Connect the feeding hose to discharge hole of feeding pump and the booster pump entrance of the host machine respectively. As figure (3)

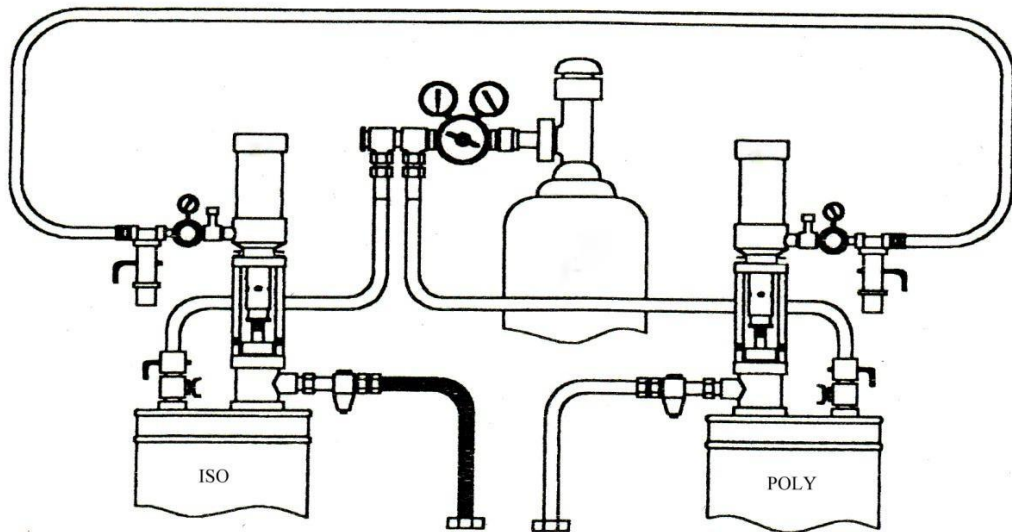

Figure (3)

3.1.2 Installation of discharging system

Connect the 15m hose to the host machine and foaming gun respectively. It is very easy. Be sure pipeline distinguish, not mistakes. Red hose for ISO and blue hose for POLY, As figure (4)

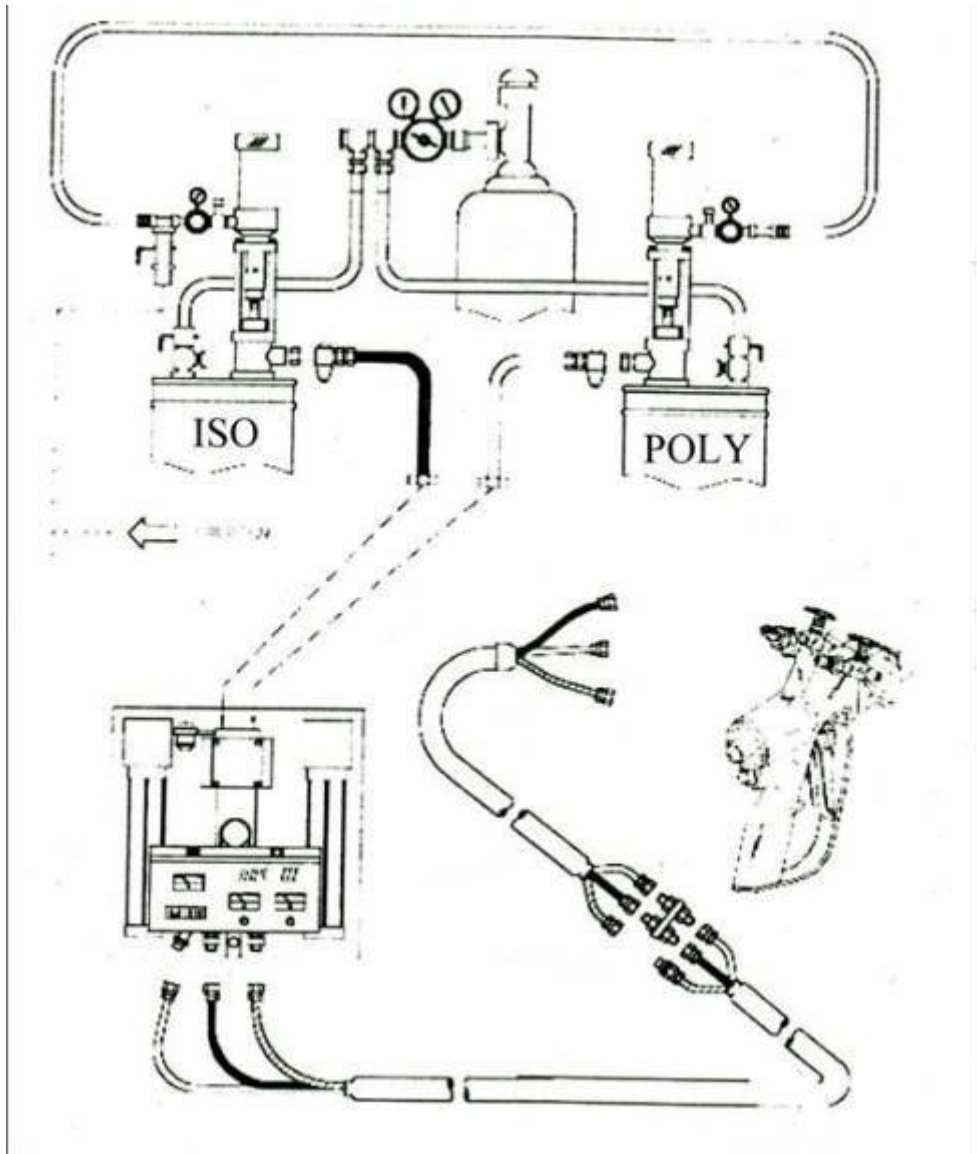

Figure (4)

3.1.3 Installation of foaming gun

Air pipe to gun connection, blue one to the connection figure (5)-①, orange one to the connection figure (5)-②, never exchange;

Connect hose to gun, red hose connect to figure (5)-③, blue hose connect to figure (5)-④, you can not to exchange them.

Connect gun wire to figure (5)-⑤.



Figure (5)

NOTICE

- Do not use plastic seal tape on all joints from the discharge hole of the host machine to the spray gun, because these are all circuit connection.
- 15m heater hose is the standard configuration, and its output voltage is 48V. You should adjust the voltage to 65V if use longer heater hose. And the joint between two heater hose must be insulated.

3.2. The connection and requirement of air supply:

3.2.1 Connect the pure air supply under 0.4CBM to the connector of the pressure regulator on hose and gun

3.2.2 From the block to gun air, it has blue air pipe and orange air pipe, blue air pipe connect to the top of the gun, orange air pipe connect to the back of the gun.





The pneumatic components like air pressure regulator, cylinder and reversing valves would be easily damaged if the air supply not clean. So, you should install an air filter

device and oil sprayer, to make sure service life of the pneumatic components and their flexible movement.

3.3. The connection and requirement of power source

Connect the tip of power line from the host machine to the 220V single-phase or 3-phase power which equipped with leakage protection switch, and power is up to 17KW for FD-211A. The color line is protective grounding wire. It should be with reliable ground protection, in case of leakage, causing unnecessary personal injury.

					
<ul style="list-style-type: none"> • Installing this equipment requires access to parts which may cause electric shock or other serious injury if work is not performed properly. Be sure your installation complies with all National, State and Local safety and fire codes. • The two wires of the instrument panel are charged when the main power turn on. So turn off the main power when maintain the instrument. 					

3.4. Panel





counter of booster pump



the PID controller of hose



the PID controller of POLY



the PID controller of ISO



the working switch of oil motor



the working switch of heaters



the working switch of hose



the working switch of booster pump

3.5. Main power switch



The main power switch electrical box in the upper left position, right rotation to open the main power, then face LED lights can be panel functions.

NOTICE
All electrical appliances are not charged but for the input power line and the black and gray line from the input power line to main switch. So, take apart or cut the main power when maintain the inside of the instrument, even if the switch is off.

3.6. Stop switch

Press the stop switch in an emergency situation, then the machine will stop working. Be sure cut off the main power if you want to maintain the equipment. After finishing maintains, turn the knob clockwise then it will reset. And equipment recovers to working state.

3.7. Hydraulic oil filling operation.



The machine needs to fill the hydraulic oil labeled :(Citgo A/W,ISO 46); Machine takes about 45 liters of hydraulic oil.

Hydraulic oil change intervals as follows: 0--90 degrees Fahrenheit for 12 months, or 1,000 hours; When more than 90 degrees Fahrenheit, the replacement period of 6 months, or 500 hours.

Specific hydraulic oil filling methods:Turn the machine back cover, unscrew the filler cap, the lubricating oil into the tank from filling hole until the oil level higher than the minimum standard within the value added to the upper limit of the best locations.

3.8. Booster DOP replacement operation



Unscrew the top cap, add DOP, tighten the cap and finished replace.
Depending on the equipment work, DOP liquid replaced once every 3-6 months.

4. System Operation

4.1. The check before operation

4.1.1 There are 2/3 DOP in the oil cup of host machine or not.

4.1.2 All the connectors are tightened or not.

4.1.3 The connection of power line is correct or not. The protective grounding wire is safe and reliable or not.

4.1.4 All the switch on the control panel is in the OFF position or not.

4.1.5 Air supply regulator is in the OFF position or not.

Don't put any parts of body in the range of spray.

Don't let the gun point to someone.

Don't look into the hole of the gun mixing chamber.

Please use safety appliances like mask, gloves, goggles and protective clothing, for the objectionable constituent in the raw material.

4.2. Initial start (the first use of the new machine)

NOTICE					
Proper system setup, startup, and shutdown procedures are critical to electrical equipment reliability. Failure to follow safety procedures will cause voltage fluctuation that can damage electrical equipment and void the warranty.					

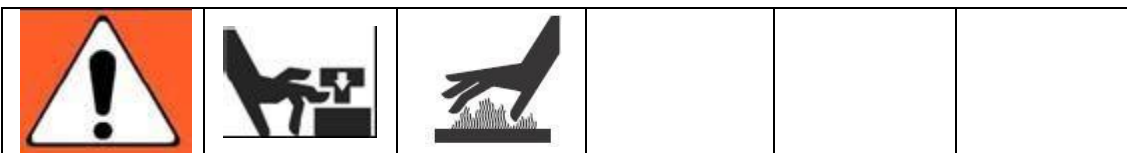

Do not operate this machine without all covers and shrouds in place.
--

Before operate the system you must make sure all fluid flow pipes, air supply pipes and power lines are connected and correct. The operator must fully understand every part on the control panel, steps as follows:

4.2.1 Turn on the POWER switch, Release the emergency stop button, press the ON / OFF button to turn on the pump motor, press the PARK key, , then the host machine work. The material system is filled by raw material and heater hose heat. Once filled up, machine will stop working automatically.

4.2.2 Remove the two transporting block beside the tip of the gun.

4.2.3 Place a clean container under two transporting block respectively. At the same time, turn on the raw material valve of two transporting block slowly, let all air in the transporting pipe out, till spray material smoothly. As figure(7)

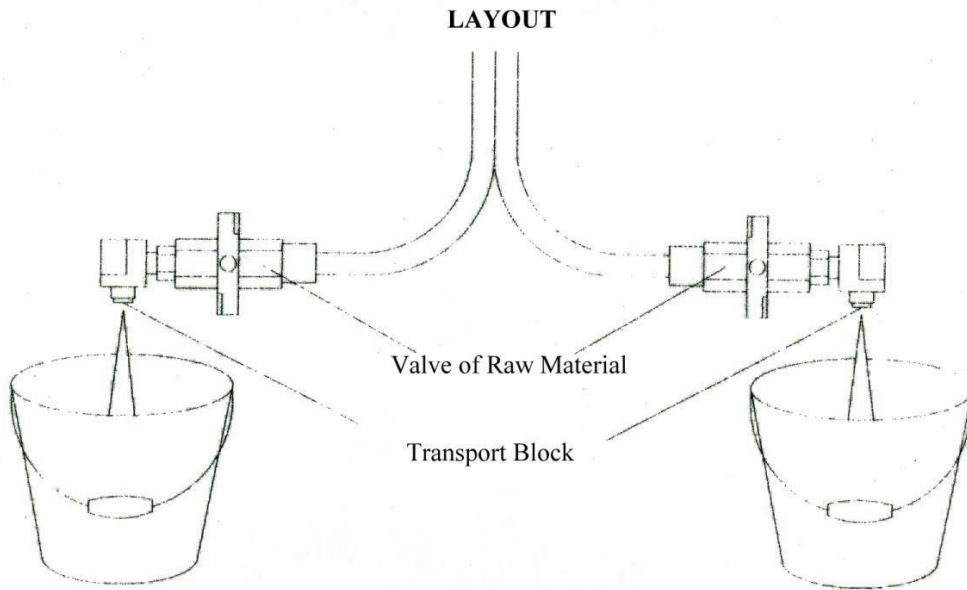





Figure (7)

4.2.4 Close raw material valve at the same time, the pressure value shown on the pressure gauge of raw material should be approximate equality. If one of them is higher, turn on the raw material valve slightly on higher side, let raw material flow out, till the two pressures are approximately equality.

4.2.5 Clean the traces of raw materials on transporting block, wipe grease, install the transporting block to the gun again. Tighten the screws, let two transporting block closely contact with the gun tip, make sure no air/material leakage and the gun tip in flexible motion.

4.2.6 Straighten the transporting pipe to avoid uneven Heating and Damage internal heating wire. Set the PID to make the heating temperature well. After temperature is up to the setting value, then improve the air supply pressure of host machine to the working pressure. Details refer to the PID manual.

					
<p>Before spraying, don't set the air supply pressure at the value of working pressure to avoid damaging pressure gauge for high pressure, and even explosion, because the raw material will expand when heated.</p>					

4.2.7 Adjust the air supply pressure to 1Mpa (reference value) by the valve.

4.2.8 Turn on the intake switch first, then the raw material valve on the two transporting block.

4.2.9 At the moment, the whole system prepared, and it can spray as long as pull the trigger.

NOTICE

Make sure turn off the raw material valve on the two transporting block when you stop working to avoid spraying due to wrong operation.

4.3. Daily shutdown steps

Note: After the end of the work, press the PARK key to the booster pump in a reset state, let the pump shaft all in the oil, avoid scratching the seal element in the pump again started.

4.3.1 Press the temperature control buttons on the control panel, turn off the ISO POLY HOSE heating power, turn off the pump motor

4.3.2 Check the spray gun. Make sure the spray gun in good condition and could work normally again, then do the next step, refer to FD-PG Foaming Gun User Manual.

4.3.3 Turn off the main power switch (POWER);

4.3.4 Close the air supply, the pressure is 0 shown on the barometer at the moment.

4.3.5 Clean the work site, make sure have finished the daily shutdown steps. Check if the surplus raw materials are enough to do next work. Prepare for it.

4.3.6 Put the feeding pump feet into DOP to make sure the chemical do not crystallization;

4.3.7 Take apart the blocks of the gun, put the gun nozzle and blocks into the Ethylene glycol monomethylether.

Schematic for Forced commutation, Stop location and Induction contactor

4.4. Daily maintains

4.4.1 Check the quantity and color of the DOP in the DOP cup of the booster pump and feeding pump. Change the DOP which discolor and failure seriously to avoid damage the seal element. You can suck up the discolored and failure grease with a suction flask, and refill the cup to 2/3 with pure DOP. Adjust the tightness of the DOP cup properly, avoid leak again.

NOTICE

You need to change the seal element if the grease in the oil cup discolors in a short time.

4.4.2 Wipe oil on the cylinder shaft evenly.

4.4.3 Finish check and maintains for spray gun following the way in the daily shutdown steps.

NOTICE

Discharge all the air pressure and hydraulic pressure before repair and maintain the system.
--

4.5. Operation of long-term shutdown

The measure is taken when the machine is not used in a long time, like shutdown in winter or not sure when to use it. To do as follow steps please:(mainly aimed at ISO)

4.5.1 Take out the feeding pump form the material drum, clean the surface where sticks the raw material with DOP.

4.5.2 Put the feeding pump to a container filled in DOP. Turn on the air valve offeeding pump, adjust the air supply pressure to 0.1-0.2Mpa.

4.5.3 Turn on the raw material valve, spray the residual material to a container, till to DOP appear, this is to clean the raw material in the system with DOP.

4.5.4 Put the feeding pump into a container filled with DOP.

4.5.5 Start-up equipment and begin spray, till all the DOP is clean up, and spray out DOP, then the material hose will be full of the DOP solvent.

4.5.6 Shutdown as daily steps. Seal all the feeding holes and discharge holes.

NOTICE

The ISO is easy to curing when touch air, so seal all the feeding holes and discharge holes strictly to avoid air come.

5. Check for Fluid Flow System and Equipment Problems

You must know the following questions as a qualified operator:

1. What kind of the normal raw material?
2. How to work of the equipment?
3. What will be the machine when it in normal work?
4. How to move the raw material in the machine?

5.1. Checking when the hydraulic pressure gauges wrong display:

Checking must from step one, then one by one. Determine by the pressure displayed on the raw material pressure gauge. The air pressure value of each material feeding pump and host machine are not same is ok because of different raw material, temperature and viscosity. You can adjust the value of air supply pressure according to the speed of material feeding pump.

5.1.1 Confirm which material is shortage and miss.

First, observe the material color spraying from the gun and the foam state, stop spraying to check when with problems. If the raw material pressure is lower, it means underfeeding of material feeding pump system. Check if the material feeding system blocking or no material in drum.

5.1.2 If underfeeding, check and repair from the farthest end to the host machine, and begin from the most basic and easily be found aspect.

5.1.3 If the raw material pressure too low check as follows:

- (1) If there are raw materials in the drum?

(2) What's the temperature of raw material?

A. High temperature will cause expand in advance of the foaming agent in the poly drum.

B. Low temperature of the drum bottom will cause raw material viscosity increases then block the material feeding pump or raw material flow impeded and can't enter the system.

(3) Material feeding pump? Refer to the "User Guide of Material Feeding Pump"

A. Running or not?

B. Turn on the air supply?

C. Air supply pressure in a proper value?

D. There is dirt on the shaft of feeding material pump? (If yes, mean it not be wiped oil for protection in advance, or the oil cup not tighten, cause to material overflow)

E. Check the filter of material feeding pump.

F. Confirm the material feeding pump body after sure there are no problems in other parts. Specially note the B, in 2 point of step3.

(4) Filter: install a filter on the Material feeding pump discharge? Or it blocks?

5.1.4 Check as follows if the raw material pressure too high

(1) If the filtering net of the transporting block on gun blocks.

(2) If there are curing and crystalline materials in the hose from raw material pressure gauge to the gun, cause raw material flow impeded.

Check according to above steps, and resolve problems as soon as possible according to the chapter in "User Guide of Spray Gun". It will cause some problems if put the opened equipment in air for a long time, like moisture come into system then lead the ISO to crystallize and solidify.

7.2 Bad spray:

If the raw material mixes badly, check two factors:

5.2.1 Temperature

(1) If material temperature too high, the material fly apart oversize, then cannot spread to bottom.

(2) If temperature too low, then mix uneven, waste material, foam in low efficiency, and bad insulation.

5.2.2 Pressure

(1) Shorten service life if pressure too high

(2) Materials mix uneven if too low.